

Directions: Please determine which of the graphs, the left or the right, is correct.

AND

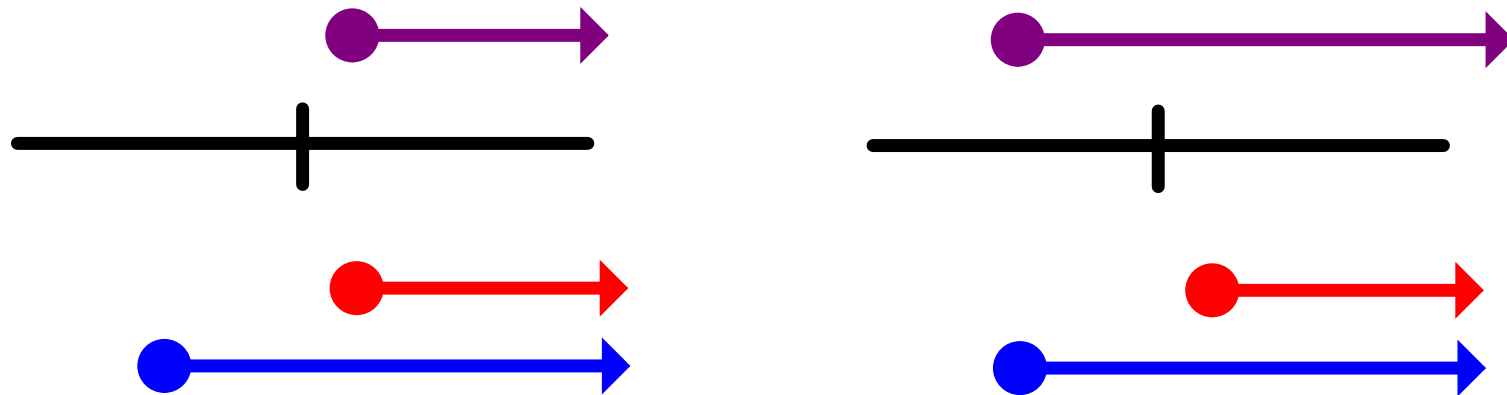

Question 1

AND-Need Two T's

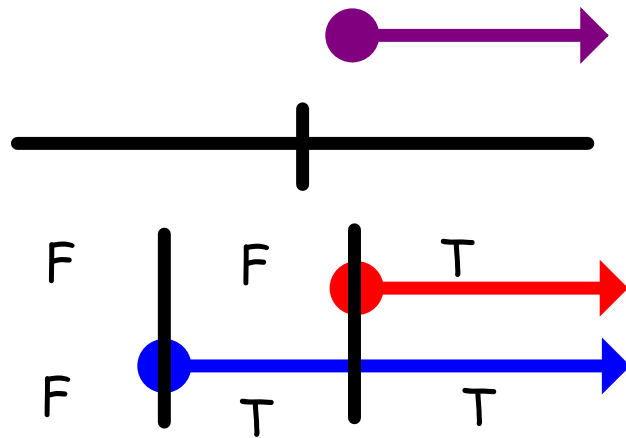

Answer 1

OR

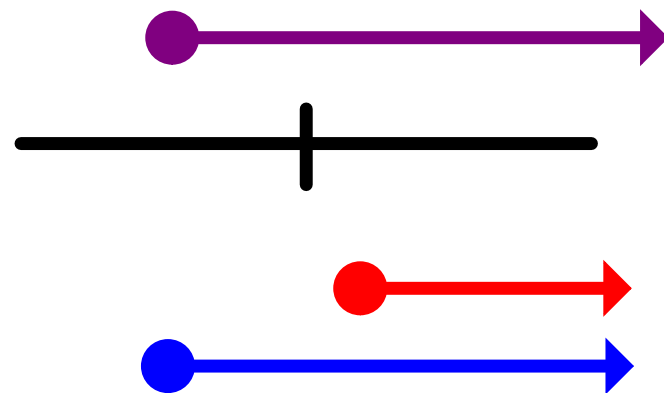
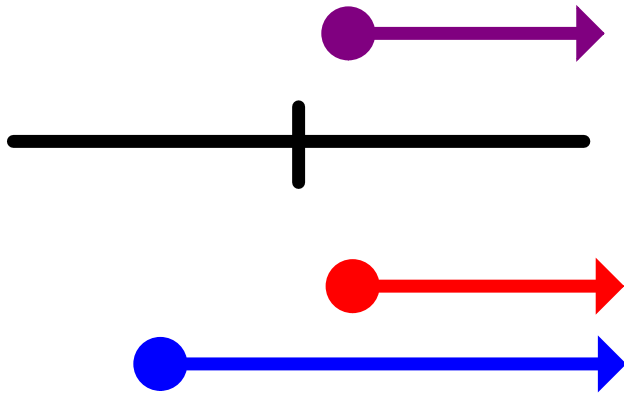

Question 2

OR-Need 1 T

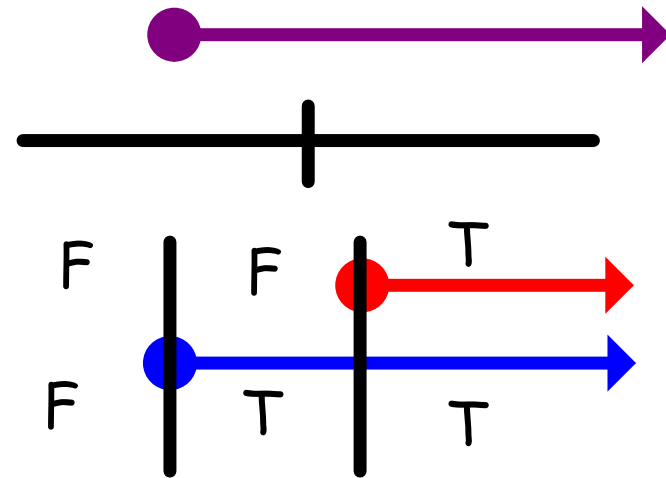

Answer 2

AND

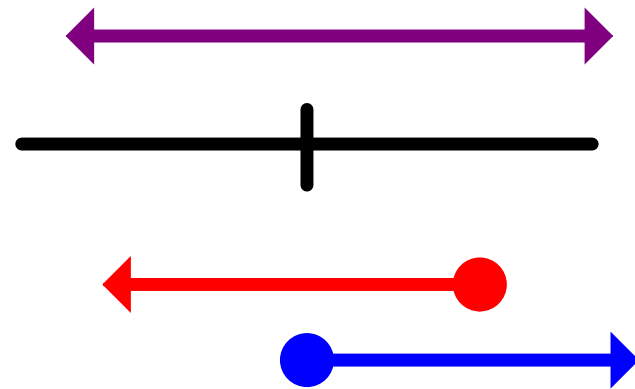
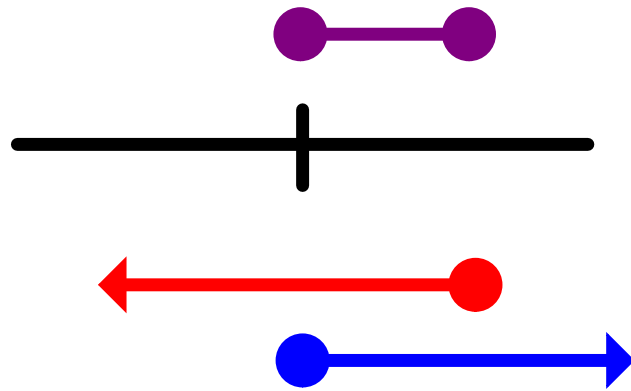

Question 3

AND-Need Two T's

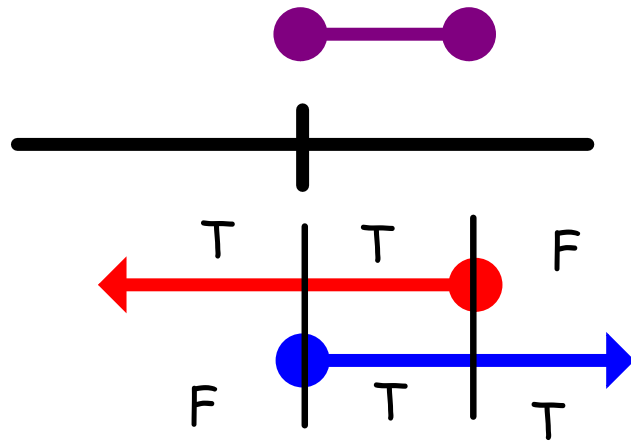

Answer 3

AND

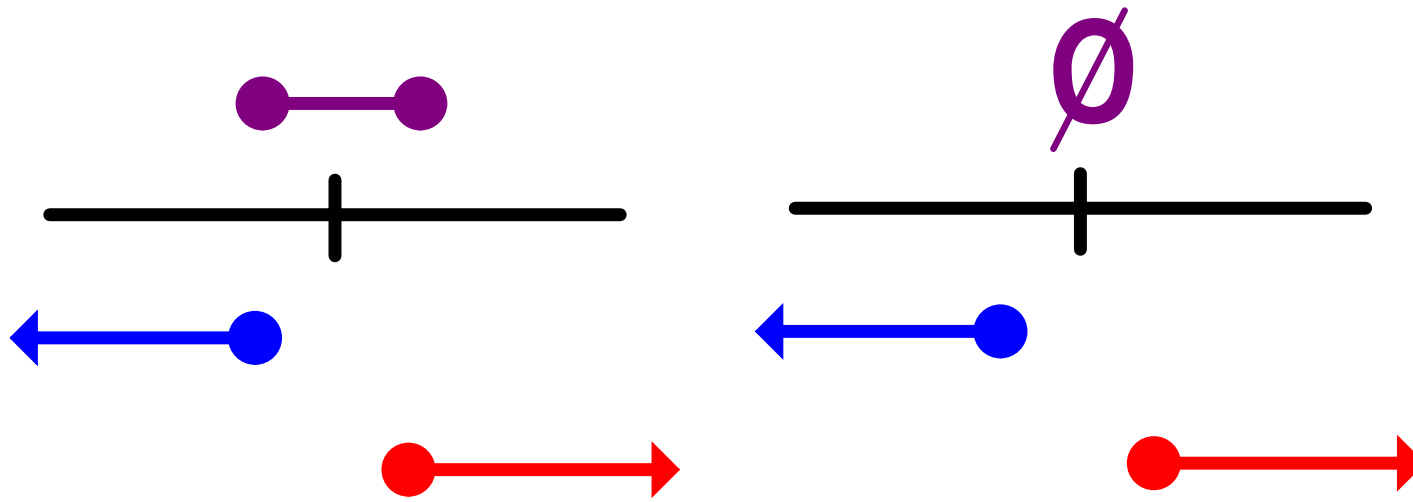

Question 4

AND-Need 2 T's

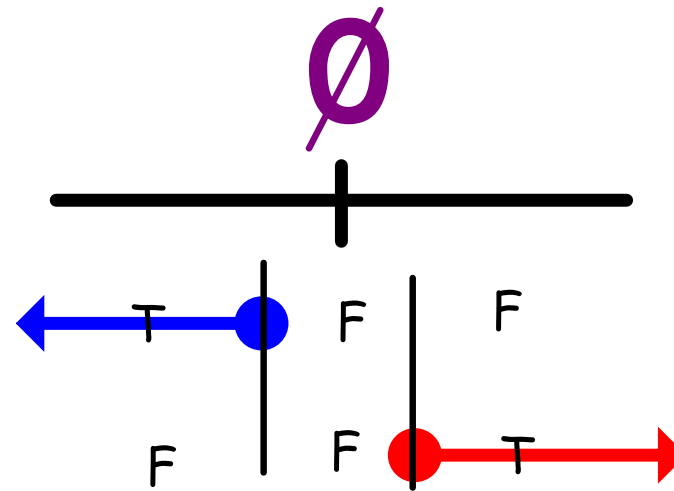

Answer 4

OR

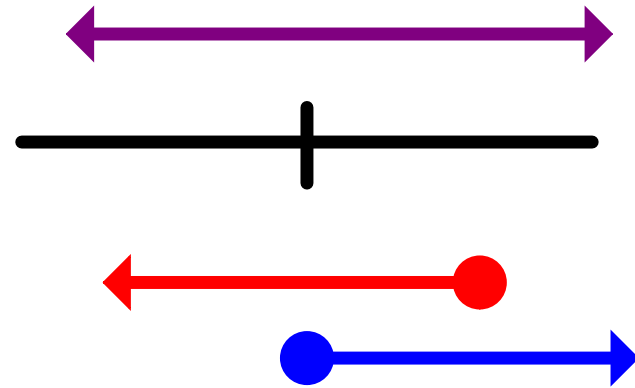
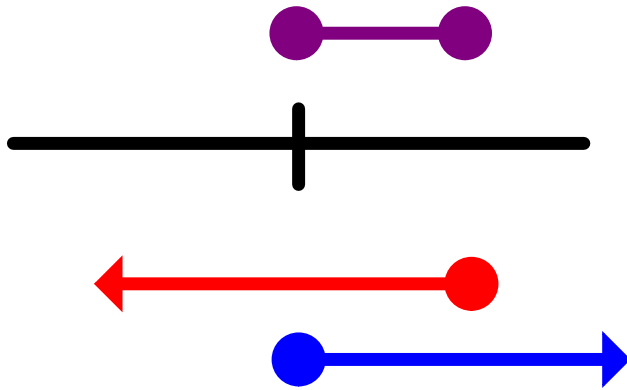

Question 5

OR

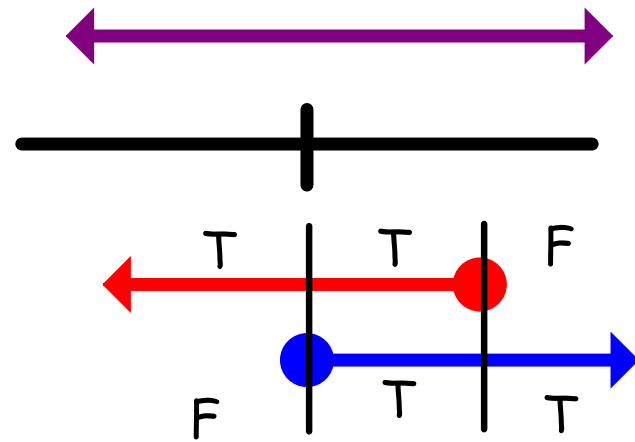

Answer 5

OR

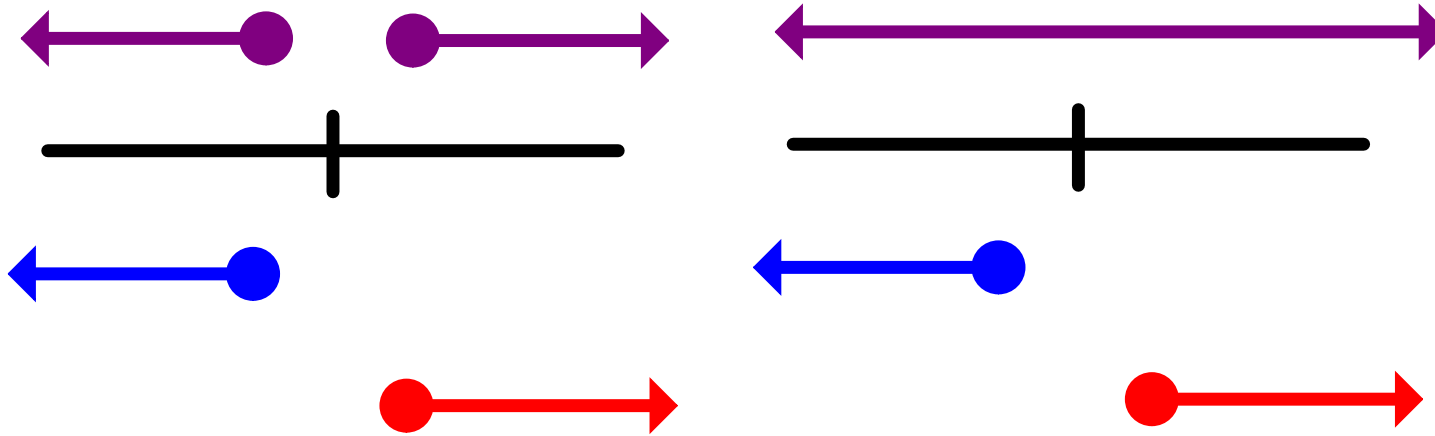

Question 6

OR-Need 1 T

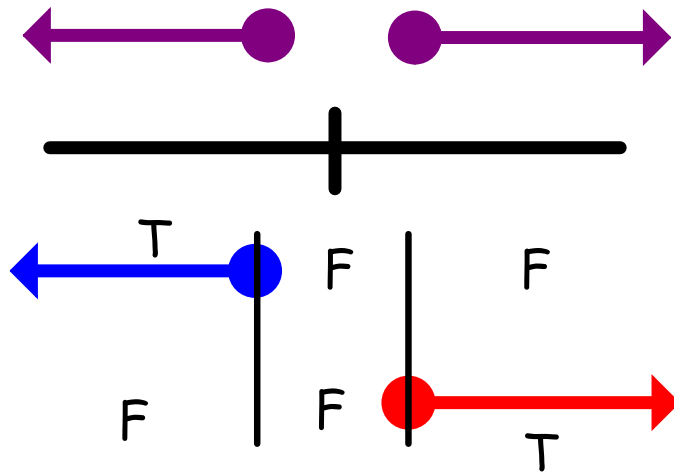

Answer 6

AND

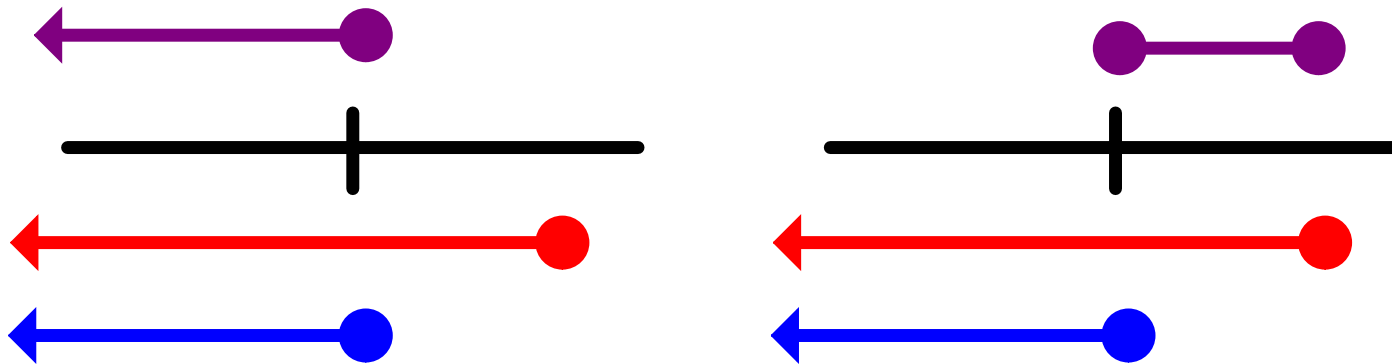

Question 7

AND-Need 2 T's

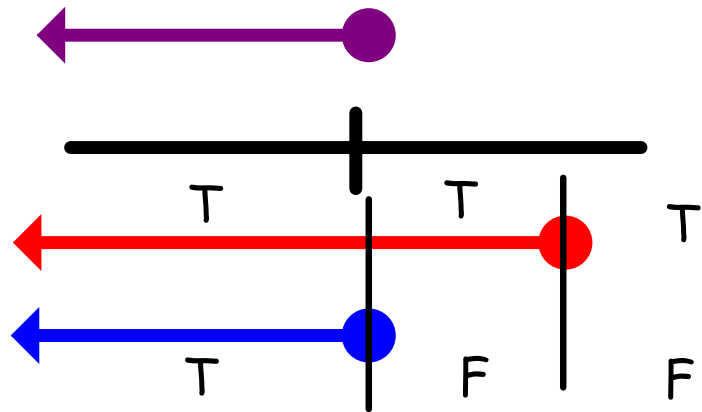

Answer 7

AND

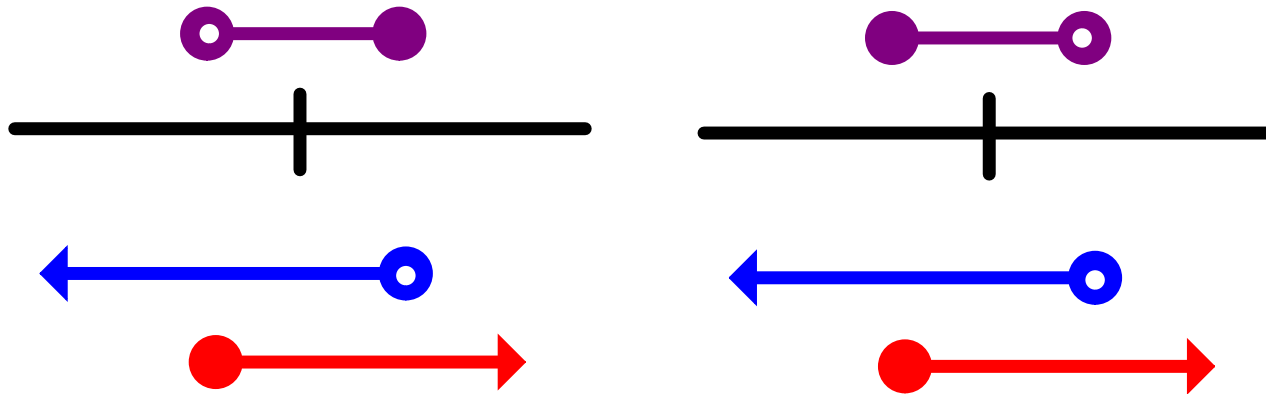

Question 8

AND-Needs 2 T's

This needs
the correct
dot.

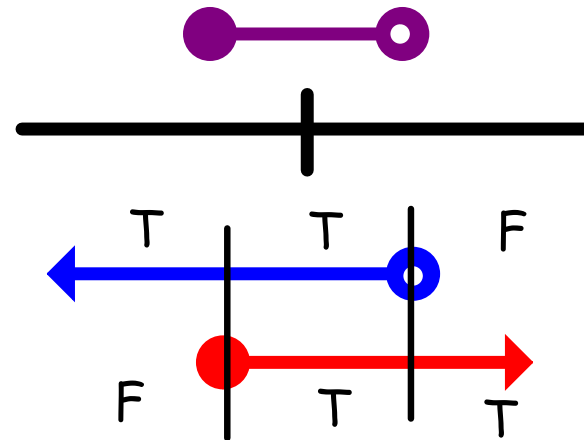

Question 8

OR

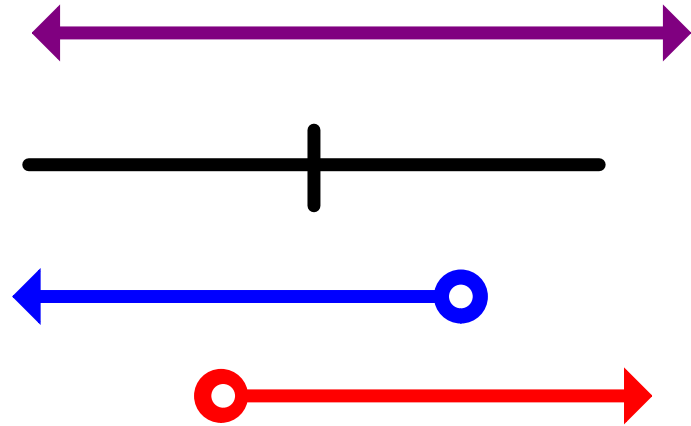
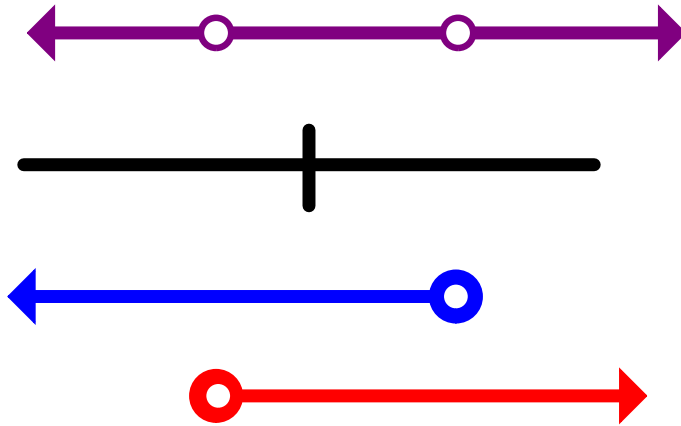

Question 6

OR-Needs 1 T

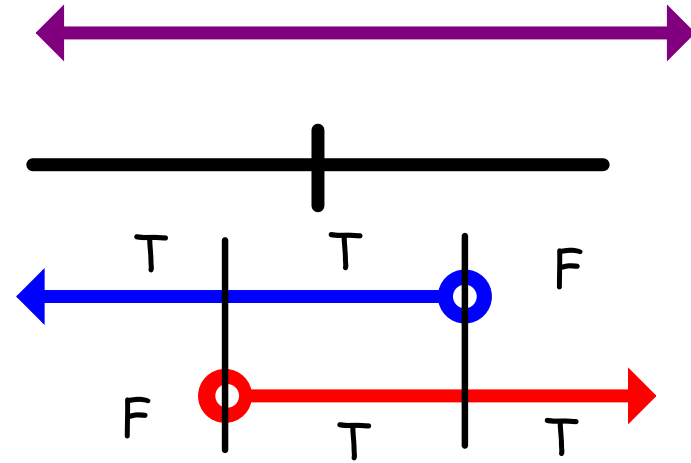

Answer 6